



- Incremental Encoders
- Absolute Encoders
- Linear Measuring Technology
- Inclometers
- Customer Specific Solutions



Kübler products for solar energy. Rugged and reliable.

Solar plants will be more and more a constant element of our infrastructure and environment. Not only the thousands of photo-voltaic elements already visible on the roof of many houses worldwide, but also the impressive solar fields of hundreds of heliostats placed in wide and uninhabited areas too, producing hundreds of megawatts by converting the sun's energy into high-temperature heat using different mirror configurations.

Encoders and other measuring systems used for the control of the mirrors must withstand a variety of harsh environmental challenges. The key-factor is the continuous and efficient operation of the plants. Downtimes, poor operating performance and replacements cause not only waste of time but are a sensitive cost-efficiency factor.

The Kübler Group manufactures its products with the goal to withstand the toughest environmental challenges. Rugged construction and innovative technologies combine to give reliable performance to the installation and assure efficiency in the energy generation process.





Kübler Headquarters, Villingen-Schwenningen, Germany



Encoders for Solar Energy

Elevation and azimuth position control of heliostats	P. 4
Angular position control of Parabolic Trough Systems	P. 6



Customised Motion and Control Systems

Customer specific solutions	P. 8
Kübler Design System	P. 9



Technologies for Solar Energy

P. 10

Founded in the year 1960 by Fritz Kübler, the family business is now led by the next generation of the family, his sons Gebhard and Lothar Kübler. Ten international group members and distributors in more than 50 countries offer local product know-how, service and advice throughout the world. Innovative product and sector solutions, as well as solutions for functional safety and a high level of service, are the reasons behind our global success. The strict focus on quality ensures the highest levels of reliability and a long service life for our products in the field. Over 480 dedicated people worldwide make this success possible and ensure that customers can continue to place their trust in our company.

Elevation and azimuth position control of heliostats

The Sendix rotary encoders have been specially designed for outdoor applications with their compact die-cast housing technology, wide temperature range (from -40°C to 85°C) and high IP protection rate of up to IP67.

They can be used in stand-alone systems or can be integrated into drives.

Heliostats in particular demand high precision and therefore the optical Sendix encoders are the best option for this type of application.

The Sendix family offers all types of interfaces - incremental, SSI, BISS or all common Fieldbus protocols - depending on the automation network.

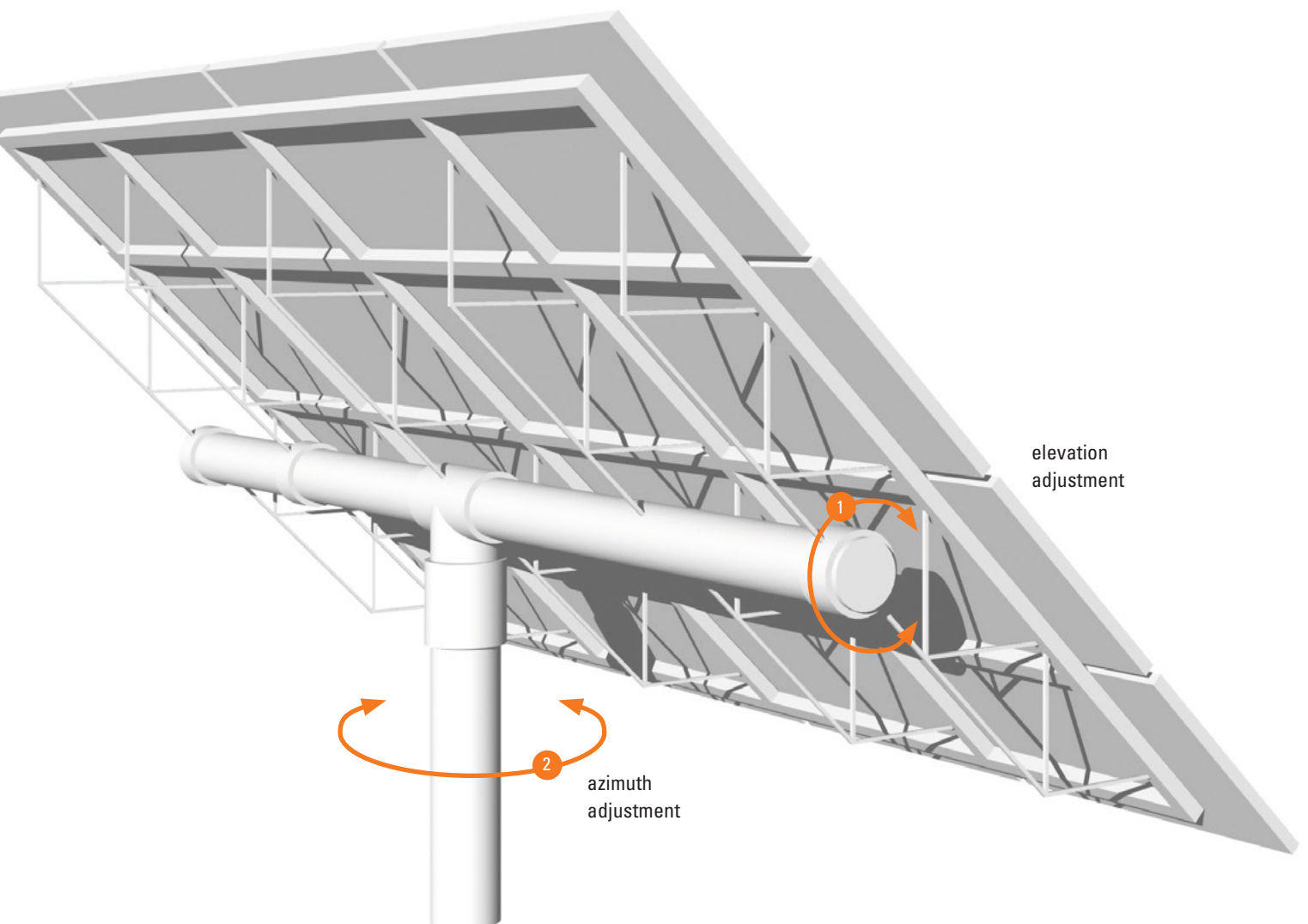

A power tower converts sunlight into electricity to be distributed through the grids.

This technology uses many large, sun-tracking heliostats to concentrate sunlight on a receiver positioned on the top of a tower. A heat transfer fluid or molten salt heated in the receiver is used to generate steam, which is directed into a turbine generator to produce electricity.

An important contribution to the efficiency of the system depends on the positioning accuracy of the heliostats in elevation and azimuth. The heliostats are typically positioned in desert areas and the equipment is exposed to environmental factors such as large temperature differences between day and night, high temperatures during the day and constant dust presence. The maintenance operation and possible downtimes must be reduced to the lowest level possible.



1 + 2 Sendix incremental encoders

The tough Safety-Lock™ bearing design ensures a long service life and high resistance to shock and vibration. The robust housing design and the wide temperature range ensure reliability outdoors. Whether installed into the drive or as a stand-alone system, the Sendix encoders offer a rugged and accurate measuring system for elevation and azimuth angles.

The Z-Pulse (zero pulse) mechanical identification allows the reference position to be found immediately during the installation.

- Sturdy bearing Safety-Lock™ Design
- Optical accuracy and resolution up to 5000 ppr
- Compact and tough die-cast housing
- Large range of mounting and installation solutions
- IP67 and operating temperature range from -40°C to +85°C
- Mechanical identification of the Z-Pulse possible

1 + 2 Sendix absolute encoders

The tough Safety-Lock™ bearing design ensures a long service life and high resistance to shock and vibration. The robust housing design and the wide temperature range ensure reliability outdoors. Easy handling thanks to external SET button and diagnostic LED. The wide number of interfaces available allows installation with any PLC type.

- Sturdy bearing Safety-Lock™ Design
- Accurate optical scanning, insensitive to magnetic fields
- Up to 17 bits singleturn and 24 bits multiturn resolution
- IP67 and operating temperature range from -40°C to +85°C
- Simple diagnostics
- Many standard interfaces (others on request)



i Inclometers

Elevation and azimuth control in photovoltaic installations have low accuracy requirements. Therefore inclinometers are an ideal economical alternative.

The IN series has an extraordinarily compact and robust aluminium housing, together with a high protection class IP67/IP69k.

The temperature range goes from -40°C to +85°C. Those sensors use analogue or CANopen outputs for 1 or 2 dimensional inclinations.

Depending on the version, different measurement ranges are possible.

Programmable vibration suppression, calibration accuracy (at 25°C) ±0.4° and zero point adjustment are further highlights of the IN inclinometers.



Angular position control of Parabolic Trough Systems

The measurement of the angular position of Parabolic Trough Systems can be carried out using robust and simple magnetic encoders or with inclinometers, depending on the installation space available.

For installation directly on the shaft, the standard Sendix magnetic rotary encoders can be used. The Limes system with customised magnetic bands is the solution for applications with very restricted installation space.

Inclinometers offer the easiest installation directly on the panel.

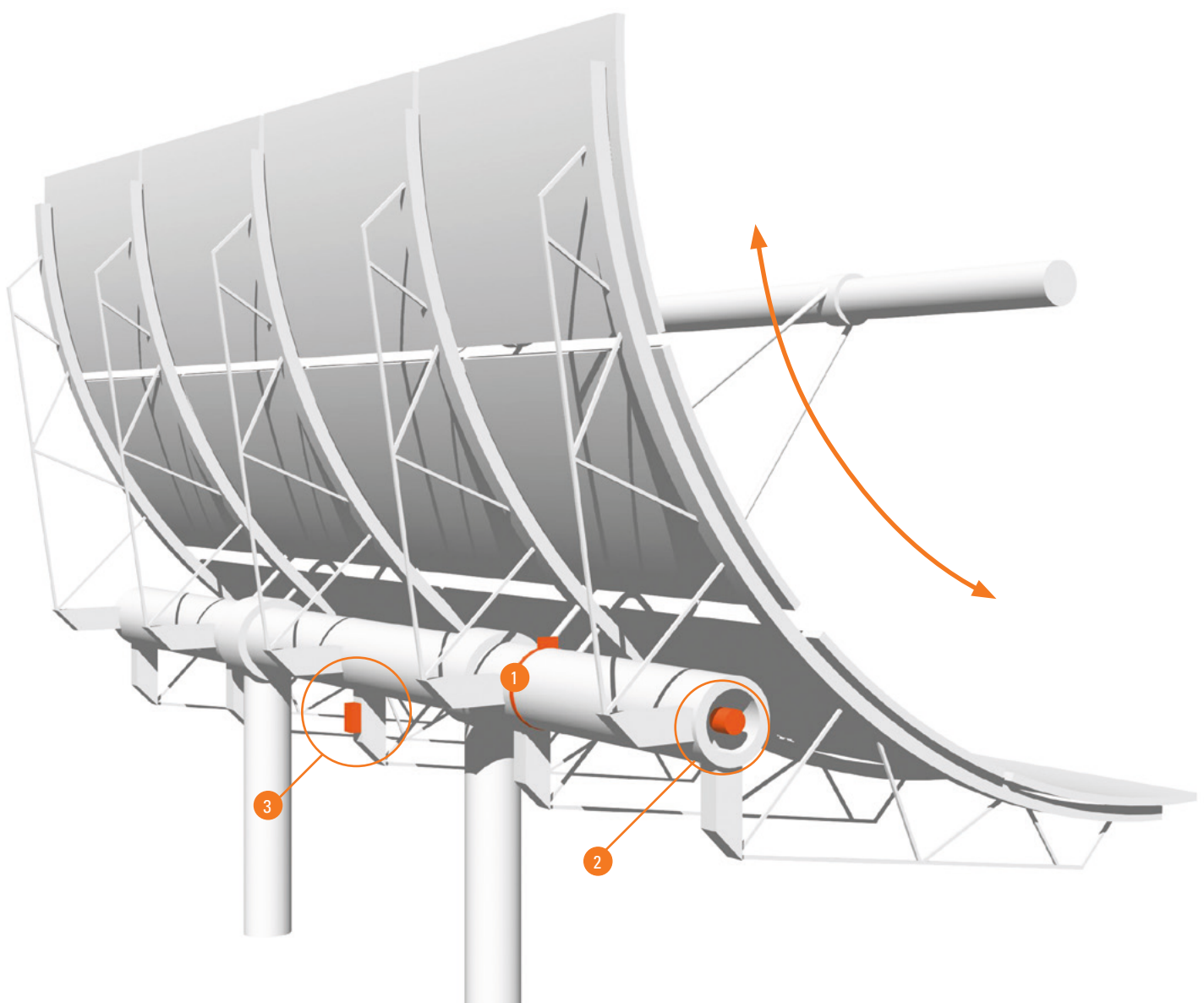

A parabolic mirror concentrates the sun's energy, thanks to its curved surface, onto a receiver pipe running along the inside of the curved surface.

This energy heats oil flowing through the pipe, and the heat energy is then used to generate electricity in a steam generator.

The parabolic trough belongs to a field including hundreds of them in parallel rows aligned on a north-south axis. Each one follows the sun on a single-axis from east to west, keeping the sun rays continuously focused on the receiver pipes.

Here it is best to use a simple, rugged and flexible measuring system.



1 Limes: linear measuring systems

- Very robust system, with extreme shock and vibration loadings
- Max. IP69k protection rate with encapsulated electronics
- Very small amount of installation space needed
- Index-pulse reference available on the magnetic band
- LED to check alignment on the band without instruments
- Withstands cyclic humidity according to moisture test as per EN 60068-3-38, and damp heat test as per EN 60068-3-78
- Custom-designed bands or rings

The Limes LI20/LI50 fulfils the requirements for CSP - parabolic trough installations. Small dimensions and non-contact sensor technology make it a flexible measuring system. Custom design for optimal integration. The index pulse available on the magnetic band allows for fast position recovery after downtime or maintenance.

2 Magnetic Sendix singleturn encoders

- Robust housing technology with Sensor Protect™ system with encapsulated electronics
 - IP69K and wide temperature range from -40°C to + 85°C
 - High shock (> 500 g) and vibration resistance (> 30 g)
 - Up to 12 bits singleturn resolution
 - Interfaces: analogue 4 ... 20 mA or 0 ... 10 V, CANopen, SSI
 - Configurable measuring range and output characteristics on request
- Absolute measuring gives unique position reference along the whole tracking movement. The housing design ensures long service life in outdoor use. Easy installation and troubleshooting with detection LED.

3 IN inclinometers

- Extremely compact and robust construction
- Measurement of 1 or 2 dimensions
- Measuring range up to 360° (1 axes version)
- Configurable measuring ranges on request
- Zero point adjustment
- Insensitive to magnetic disturbances
- Analogue or CANopen interface

Absolute measuring gives unique position reference along the whole tracking movement. The housing design ensures long service life in outdoor use. Easy installation and flexible use thanks to the different interfaces.



Customised drive and control solutions

Our OPS department offers complete drive and control solutions for your applications. With a network of strategic partners we cover all aspects of the automation chain for solar applications. Our range includes specific measuring systems, integrated drives, digital and analogue feedback systems as well as complete drive solutions.

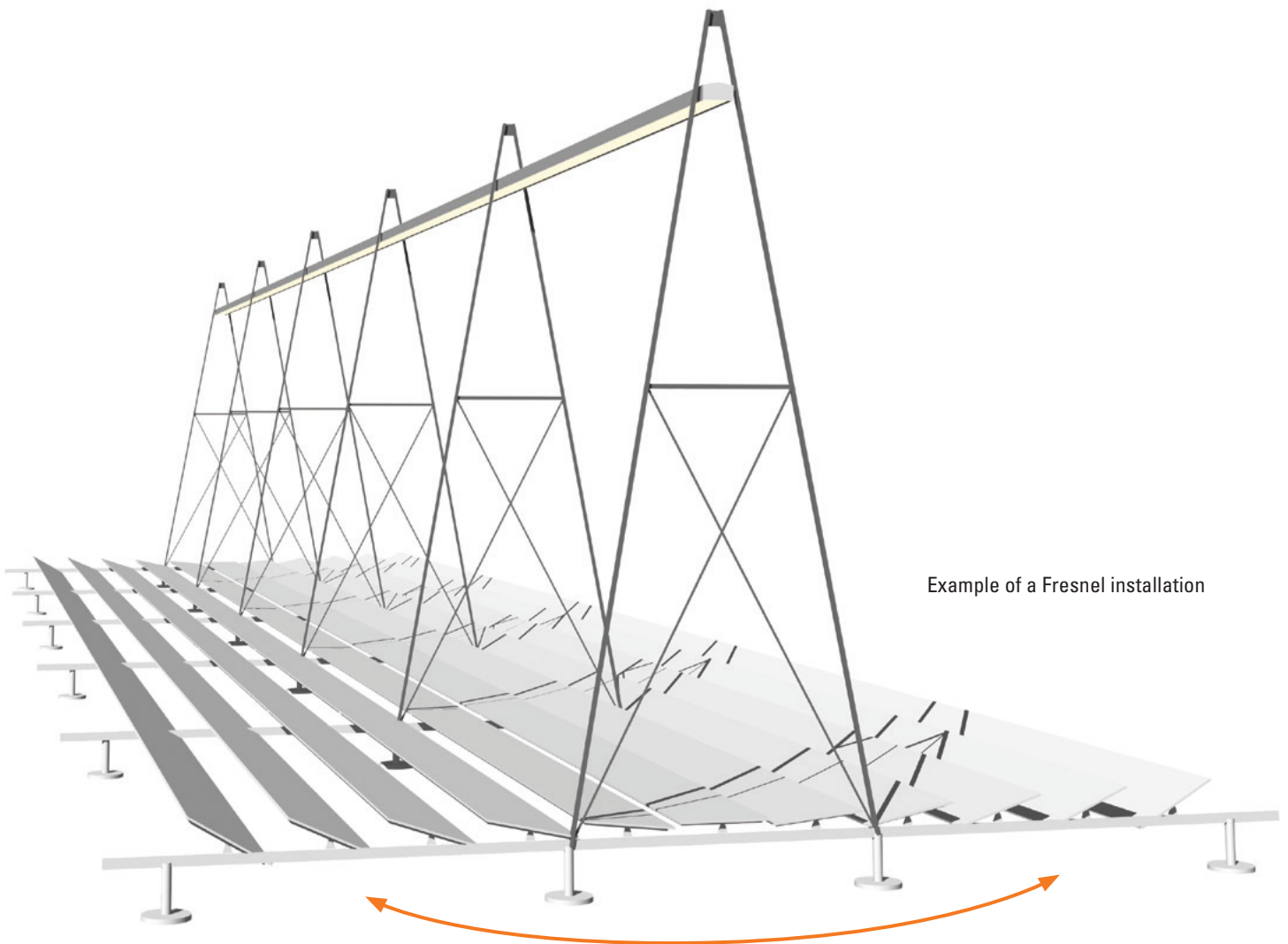

Example of a Fresnel installation

Integrated drive solutions

Complete system with motor, gears and controller from a single source specially designed for your application:

- Intelligent bus-compatible drives systems
- Custom-designed compact drives
- Integration of the firmware into the application control

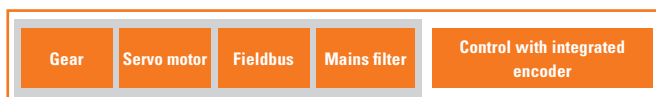

Application examples

- Custom integrated for Fresnel installations
- Spindle-type linear actuators for elevation adjustment
- Integrated measuring system with high-precision drive for parabolic troughs
- Compact drive with integrated fieldbus controller
- Custom position feedback systems with mechanical integration solution

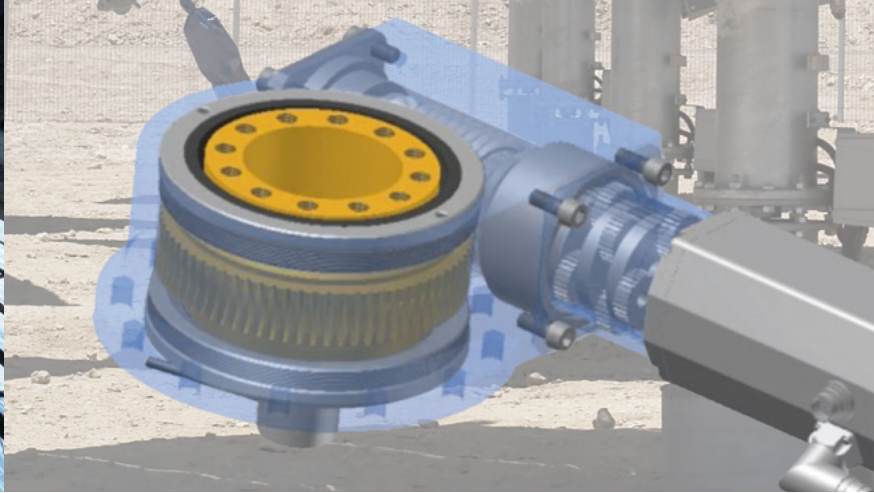
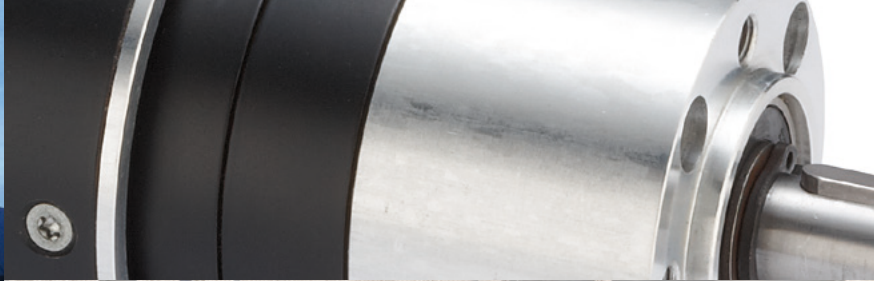

Kübler Design System

The Kübler Design System is a method approach to your solution. Working together with your engineering team, we will develop a customised solution with components designed solely for outdoor applications.

We are your partner from the initial analysis of the requirement through to the final industrialisation of your product.

Our services for your project

- Analysis / design
 - Understanding climatic conditions
 - Define required precision
 - Installation and maintenance concept
 - Solution to extend service life of the system
- Prototype and approvals with on-site technical assistance
- Industrialisation and logistical service adapted to the specific needs of solar projects

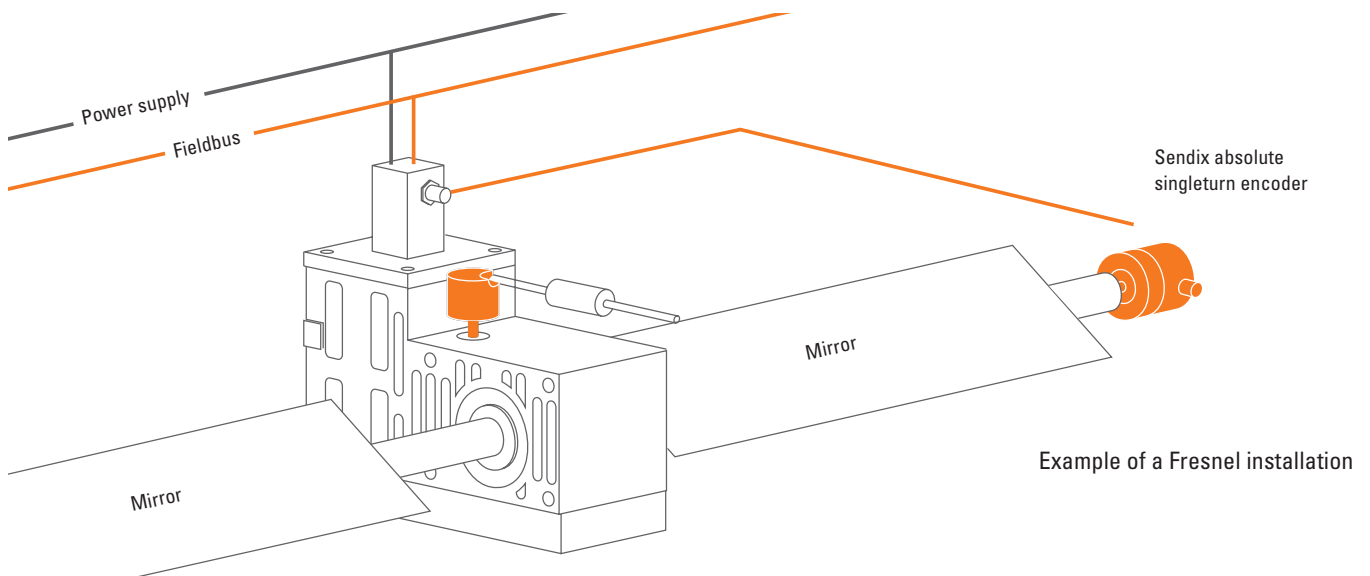

i Advantages of customised integrated drive solutions

- High reliability as all components are selected and designed-in for outdoor environments
- Special focus on longer service life in the definition of the product
- Simple installation of the system thanks to high integration level
- Solution developed to ensure easy maintenance under the specific conditions of a solar plant
- Warranty and support from a single source
- Reduced cost of ownership

Technologies for solar energy

Innovations come from experience. Kübler products benefit from 55 years experience in automation engineering. Over the years they have undergone ongoing development and been optimised for use in drives, in outdoor and offshore applications and not least in solar energy. Small details make a big difference. Our products feature many intelligent, high-quality extras, which offer our customers technical advantages which give a significant contribution to the availability of the plant and reduction of downtimes.

Rugged bearings: Safety-Lock™



The Sendix encoders offer higher reliability and longer service life, offer a very sturdy, rugged bearing construction as a result of the Kübler Safety-Lock™ technology. Encoders with Safety-Lock™ tolerate installation errors and high loads on the shaft, such as occur with wide temperature fluctuation or vibration. Interlocked, positive-fitting bearings, large bearing spans and a special assembly technique make a contribution here.

Optical encoder technology



100 percent resistant to magnetic fields – extremely compact design. Even strong magnetic fields, as occur in the vicinity of brakes or drive motors, pose no problems for the sensor technology of optical encoders. The technology dispenses with any components that may be susceptible to magnetic influences and allows for high scanning rates. The multiturn gear module – developed from special materials – is effective thanks to its double bearing layer and the specially developed gear teeth, resistant against wear, and can be used for high speeds up to 9000 rpm. As a result of the proven drive, the encoder has no need of a battery to store the number of revolutions.

Magnetic sensor technology



Magnetic sensors are particularly robust while having a compact structure. The magnetic technology allows fully encapsulated electronics and thus an IP69k protection. They offer a particularly economic solution for short strokes, applications requiring a high repeatability accuracy or for manual position monitoring.

Seawater resistant



Although it has already proved itself in harsh environments, the Sendix encoders family has been tested and certified according to the IEC 68-2-11 standards about resistance to the effects of salt-spray water over a period of up to 672 hours – the highest test level. The high certification level for the Sendix encoders gives further reliability for a high level of resistance against corrosion.

Shock and vibration resistant



Kübler encoders avoid serious, expensive failures right from the start – even with increased levels of axial loading, shock and vibration. This can eliminate enormous service costs and expensive downtimes in plants and installations worldwide. The high IP protection level makes these devices less sensitive to wet conditions outdoors, and for temperatures between -40°C and +90°C or for altitudes over 3000 meters above sea-level.



Housing technology for outdoor use



The strong die cast housing of the Sendix encoders has extra thick walls. It is fastened to the encoder flange by multiple crimping. The high protection (up to IP69k) and the wide temperature range from -40°C to +90°C allow an outdoor use without any problem. The die cast housing has a very strong base, on which the connector flange is fastened with four screws.

The Sensor-Protect™ design of the M36 encoders allows, thanks to entirely compound-filled electronics, the highest protection, IP69k. Thanks to the separate mechanical components with mechanically protected shaft and labyrinth seals, no additional protection is required in case of steam or highpressure cleaning.

Insensitive to interference: OptoASICs



The resistant Kubler OptoASIC technology offers a very high integration density of components.

This means, on the one hand, that the average reliability in the application can be increased significantly and, as a further benefit, the technology offers proven quality EMC characteristics and shock resistance.

Fixing and connection solutions



Kübler offers a wide choice of standard fixing and connection options, with which the desired encoder variants can be combined in a modular design principle. In addition to this individual, customised solutions can be worked out.

Electrical interfaces

Kübler encoders boast a wide variety of interfaces. Along with incremental interfaces such as TTL / HTL and SinCos there are also absolute interfaces such as SSI and BiSS. Absolute encoders with fieldbus interfaces such as CANopen, PROFIBUS, PROFINET and EtherCAT are also available. The outputs and supply voltage are short-circuit protected.



Tailor-made solutions – Kübler Design System

With the KDS method our customers receive a lasting solution to lowering costs, reducing the number of models available or eliminating quality deficiencies. With KDS we develop product and engineering solutions together. The method stands out because of its structured process; this delivers innovation through experience and cooperation with the customer.

Gebhard and Lothar Kübler, Managing Directors Fritz Kübler GmbH

The Kübler Design System – satisfying customer demands

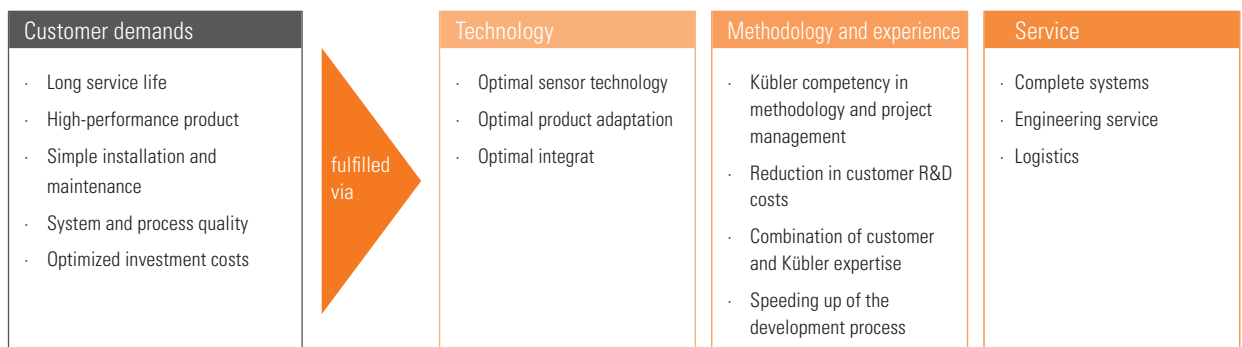

The 4 phases of the Kübler Design System

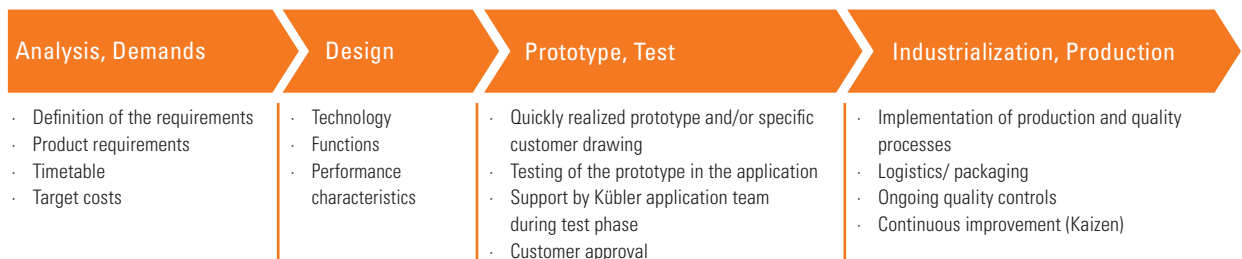

PRESALES

- Selection tool
- Kübler website: Product Finder

Kübler industry specialists for applications and complete integration solutions – on site worldwide.

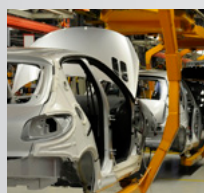

- Delivery Service 10 by 10
- 48 h Express and Repair Service

Sample Service – Fast delivery of customized versions



Kübler Service for Planning Dependability

Fast, reliable service and professional advice have top priority at Kübler. We are globally on your doorstep in 8 service and application centres and offer our customers planning dependability. Our processes and services are certified and are constantly being improved.

24one 24one delivery promise

Manufacturing in 24 hours. For orders placed on working days before 9 AM, the product will be ready for dispatch on that same day. 24one is limited to 20 pieces per delivery.



Sample Service

We manufacture samples of special designs or according to customer specification within shortest time.



10 by 10

We will manufacture and deliver 10 encoders within 10 working days (365 days a year - with the exception of 24th Dec. until 2nd Jan.)



Technical Support

Kübler' applications team is present on site all over the world for advice, analysis and support.



48 h Express Service

We can process your order within 48 hours; we can ship stock items the same day.

Kübler Germany / Austria	+49 7720 3903 952
Kübler France	+33 3 89 53 45 45
Kübler Italy	+39 0 26 42 33 45
Kübler Poland	+48 6 18 49 99 02
Kübler Turkey	+90 216 999 9791
Kübler China	+86 10 8471 0818
Kübler India	+91 8600 147 280
Kübler USA	+1 855 583 2537



Safety Services

- Adapted service packages
- Individual customer solutions



AFTERSALES



Service Excellence provided by Kübler application specialists for target sectors



Service Centres, globally on your doorstep: Advice, analysis, support during installation in over 50 countries

Product security – replacement models at the end of the product life-cycle



Product information

We offer additional information on our products and system solutions in the following main catalogs:

Position and Motion Sensors

- Incremental and absolute encoders
- Fieldbus and Industrial Ethernet encoders
- Bearingless encoders
- Explosion protected encoders ATEX / IECEx
- Linear magnetic measuring systems
- Draw-wire encoders
- Inclinometers
- Connection technology



Order-No. German **R.100.568**
 Order-No. English **R.100.569**

Counters and Process Devices

- Pulse counters and preset counters
- Hour meters and timers
- Frequency meters and tachometers
- Combination time and energy meters
- Position displays
- Process displays and controllers for temperature, analog signals and strain-gauge
- Setpoint adjuster



Order-No. German **R.100.156**
 Order-No. English **R.100.157**

Transmission Technology

- Slip rings, modular system
- Slip rings, bearingless modular system
- Slip rings, contactless transmission
- Slip rings, compact and low-maintenance
- Slip rings, Ethernet transmission
- Optical fiber signal transmission modules
- Cables, connectors and pre-assembled cordsets



Order-No. German **R.600.948**
 Order-No. English **R.600.948.001**

Functional Safety

- Certified incremental and absolute encoders
- Certified explosion-protected encoders ATEX / IECEx
- Modules for safe drive monitoring
- Safe fieldbus gateways
- Safe speed monitors
- Adapted service packages
- Connection technology



Order-No. German **R65001.0001**
 Order-No. English **R65001.0002**



Solar Energy

www.kuebler.com



www.kuebler.com/solarenergy

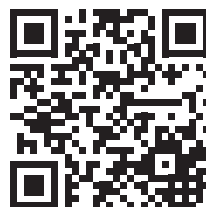

Kübler Group
Fritz Kübler GmbH
Schubertstrasse 47
D-78054 Villingen-Schwenningen
Germany
Phone +49 7720 3903-0
Fax +49 7720 21564
info@kuebler.com
www.kuebler.com

■■■ *pulses for automation*

RG4-004.0002.05.050 16 ES